

TUMÄ

# Flow2one

Fresh Air Exchanger

O<sub>2</sub><sup>+</sup>

Clean<sup>+</sup>

Health<sup>+</sup>



# Continuously Refresh Indoor Air Achieve Pure Breathe

The TUMÄ Flow2one, through nonstop air circulation, the dirty air is continuously removed. The fresh air is brought in and the indoor purification is enhanced.

\* This product shall installed near the wall of the balcony or window in case of further construction and maintenance. Other special wall surfaces or outdoor environments require professional persone.

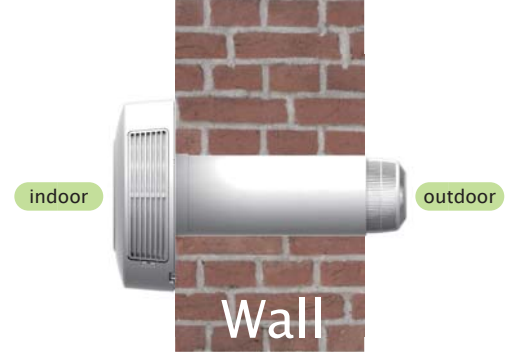

Flow2one *Plus+*



Flow2one



Flow2one *Light*

Filters PM2.5

**EXCELLENT**

MEDIUM

MEDIUM

Filters Formaldehyde

**EXCELLENT**

LOW

LOW

Reduces CO2

**EXCELLENT**

MEDIUM

MEDIUM

Air Exchange

**EXCELLENT**

MEDIUM

LOW

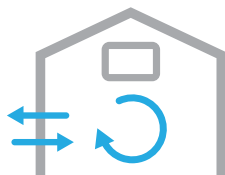



# Flow2one *Plus+*



**Clean<sup>+</sup>**  
Air Purify



**O<sub>2</sub><sup>+</sup>**  
Fresh Air



**99.9%**  
PM2.5 Filter



**Health<sup>+</sup>**  
VOC Filter

## Refresh air quickly

200m<sup>3</sup>/h strong fresh air in  
70m<sup>3</sup>/h exhaust polluted air in

## Micro positive pressure protection

The positive pressure will push out dust and dirty air through the cracks in the window or door. At the same time this blocks outdoor PM2.5 and other pollutants from entering the room.

## Double Filtering, Super Purification

H11 High Efficient Filter, Purifies 99.9% of PM2.5.  
VOC Active Carbon, Filters odor, formaldehyde, methane, etc.

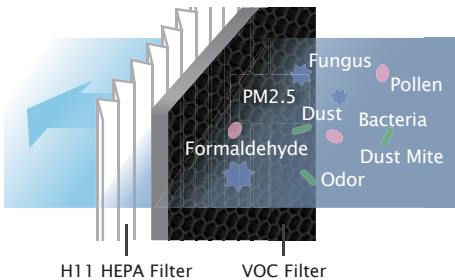

## Smart Air Purifiers

The high-precision sensor can auto-monitor CO<sub>2</sub> and PM2.5. It will automatically adjust the intake and output volume of fresh air, allowing you to enjoy fresh air around the clock.

## 70% Heat Exchange Efficiency

Warm in winter! Cool in summer!

## Specification

unit : mm

Model : AHR15N24

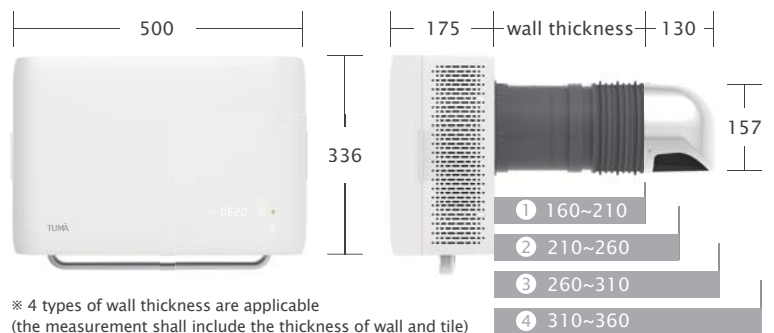

Direction	Intake / Exhaust		
Air Flow(Intake) (m <sup>3</sup> /h)	85	140	200
Air Flow(Exhaust) (m <sup>3</sup> /h)	40	70	70
Noise (dB(A))	26	39	44
Power Consumption (w)	10	30	46
Control	Remote Control		
Heat Recovery (%)	70		
Air Quality Monitoring	PM2.5/CO <sub>2</sub>		
Filter	HEPA H11 / VOC		
Mounting Options	Wall		

※ Specifications in this catalog are preliminary specification for reference. Specifications are subject to change without notice.

※ The above data is tested with the new filter. The environment and filter usage time will affect the test results.

# Flow2one *Light*

intake type



## 70m<sup>3</sup>/h Fresh air in Micro Positive Pressure Protection

Vent in your house by injecting fresh outdoor air, the clean air will flow and generates a positive pressure environment.

## 3-layer Filter Protection Filtering 99.9% of PM2.5

- **Pre-Filter** —————  
to grab human hair, dust and pet hair.
- **Anti-BAC Layer** —————  
Kills bacteria, virus and all forms of germs etc, to prevent entering the inner layer of the filter. After SGS testing, reduction of Bacteria 99.9%.
- **PM2.5 Filter** —————  
to clean out PM 2.5 particles, bacteria, pet dander and dust mites. After SGS testing, Filtering 99.9% of PM2.5.

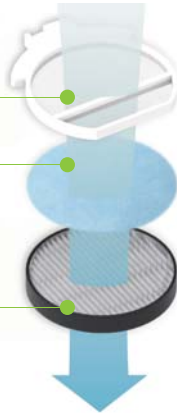

## Mini, stylish and Flexible installation Refresh Air Everywhere



## Specification

unit : mm

Model : AHR10T00

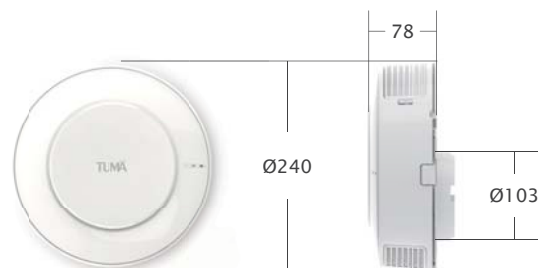

Direction		Intake		
Air Flow	(m <sup>3</sup> /h)	30	40	70
Noise	(dB(A))	24	30	45
Power Consumption	(w)	1.7	3	9
Control		Remote Control		
Filter		Pleated filter (Purification PM2.5+ Antibacterial)		
Mounting Options		Well / Window / Ceiling / Cupboard		

\* Specifications in this catalog are preliminary specification for reference. Specifications are subject to change without notice.

\* The above data is tested with the new filter. The environment and filter usage time will affect the test results.



# Flow2one

Single Room Fresh Air Exchanger



## Enjoy Fresh Air Any Time

The TUMÄ Flow2one has been designed to purify the indoor air. Certified by SGS, it can effectively filter PM2.5 and bring regulated outdoor fresh air into your home. The TUMÄ Flow2one allows your home to introduce clean fresh air without opening windows throughout the day and night.

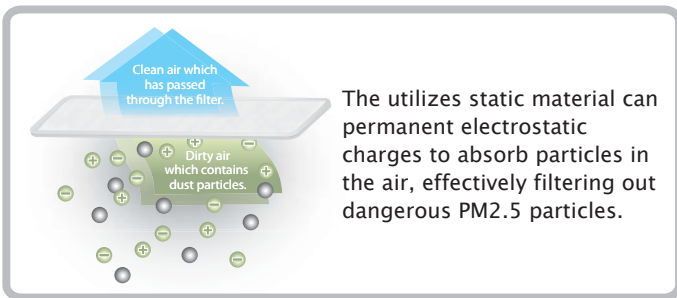

## 1.9 Watts Super Energy Saving

DC motor technology with merely 1.9W of power consumption. Annual energy costs to run 24/7 would be markedly low also. Truly a better value for your family home.

## 42% Heat Exchange Efficiency

Flow2one is like a mini heat exchanger. Through heat exchange, the indoor-outdoor temperature difference can be reduced. The indoor and outdoor air circulate continuously allowing your home to be well ventilated and comfortable even without opening windows.

## Automatic Duct Cleaning

Once this product is plugged in, it cleans the ventilation duct automatically 3 minutes every 24 hours.

## Specification

unit : mm

Model : AHR10N24 / AHR10N33

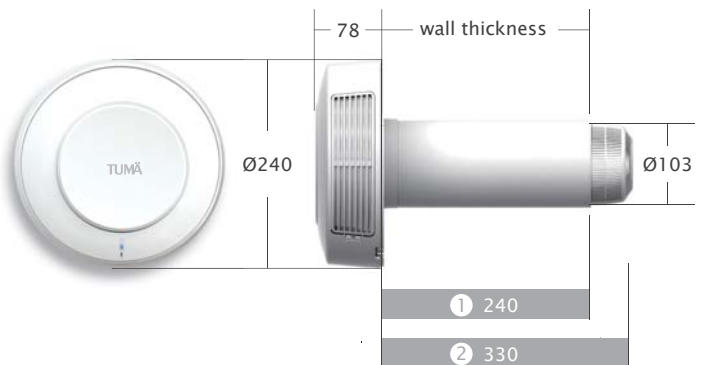

Direction		Intake / Exhaust	
Air Flow	(m <sup>3</sup> /h)	24.3	34
Noise	(dB(A))	27	32
Power Consumption	(w)	1.9	2.7
Control		Remote Control	
Heat Recovery	(%)	42%	
Filter		PM2.5	
Mounting Options		Wall	

\* Specifications in this catalog are preliminary specification for reference. Specifications are subject to change without notice.

\* The above data is tested with the new filter. The environment and filter usage time will affect the test results.



PURE AIR  
Enjoying Your Every Breath

